



OWNER'S MANUAL

Indoor Unit

MODELS:

3VIR09HP230V1AH
3VIR12HP230V1AH
3VIR18HP230V1AH
3VIR24HP230V1AH

Thank you for choosing our product.
Please read this Owner's Manual carefully before
operation and retain it for future reference.

To download an electric version of this manual visit
<https://gree-comfort-dev.web.app/system-documentation/>

Thank you for choosing a Vireo GEN3 (3VIR) Heat Pump System!

You can feel confident in your selection because the same pride in craftsmanship and engineering knowledge that goes into millions of other GREE installed products worldwide has gone into your unit.

Please read this owner's manual carefully before operation and retain it for future reference.

TABLE OF CONTENTS

Introduction	3
Nomenclature.....	4
Safety Precautions.....	5
Part Names.....	7
System Functions	8
Operation of Wireless Remote Controller	10
Damaged or Lost Remote Controller.....	16
WIFI Setup.....	17
Care and cleaning.....	18
Troubleshooting.....	19
Energy Saving Tips.....	20
Warranty.....	21



Owner's manual



FAQ

INTRODUCTION

Superior Design for Superior Performance

GREE Inverter-driven, Mini Split Heat Pumps are beautifully designed to deliver effective cooling or heating, while fitting unobtrusively into any decor. The indoor unit's aesthetically pleasing, minimalist design blends nicely in any home or office.

Your unit offers quiet, energy-efficient comfort, powered by GREE famous G10 Inverter technology. To speed up the process of bringing conditioned air exactly where you want it, the unit features both horizontal and vertical air flow control. Customizable mode controls allow you to adjust fan speeds, select sleep-time settings and more, all through the easy-to-use wireless remote controller, or an optional Wired Controller.

There's even a "Turbo", Power Failure Memory and other advanced features to make your system even more versatile, for year-round comfort and energy savings.



Front Panel Display

The front panel on the indoor unit contains system status lights and easy-to-read LED display.

NOTE: The indoor unit display panel can be turned ON or OFF via the LIGHT button on the remote controller. See "LIGHT" button description for more detail.

- This is the general introduction and the color of in dicator is only for reference. Please refer to the actual display.
- Display content may be different from the actual. Please refer to the actual display.

NOMENCLATURE

EXAMPLE: 3VIR12HP230V1AH

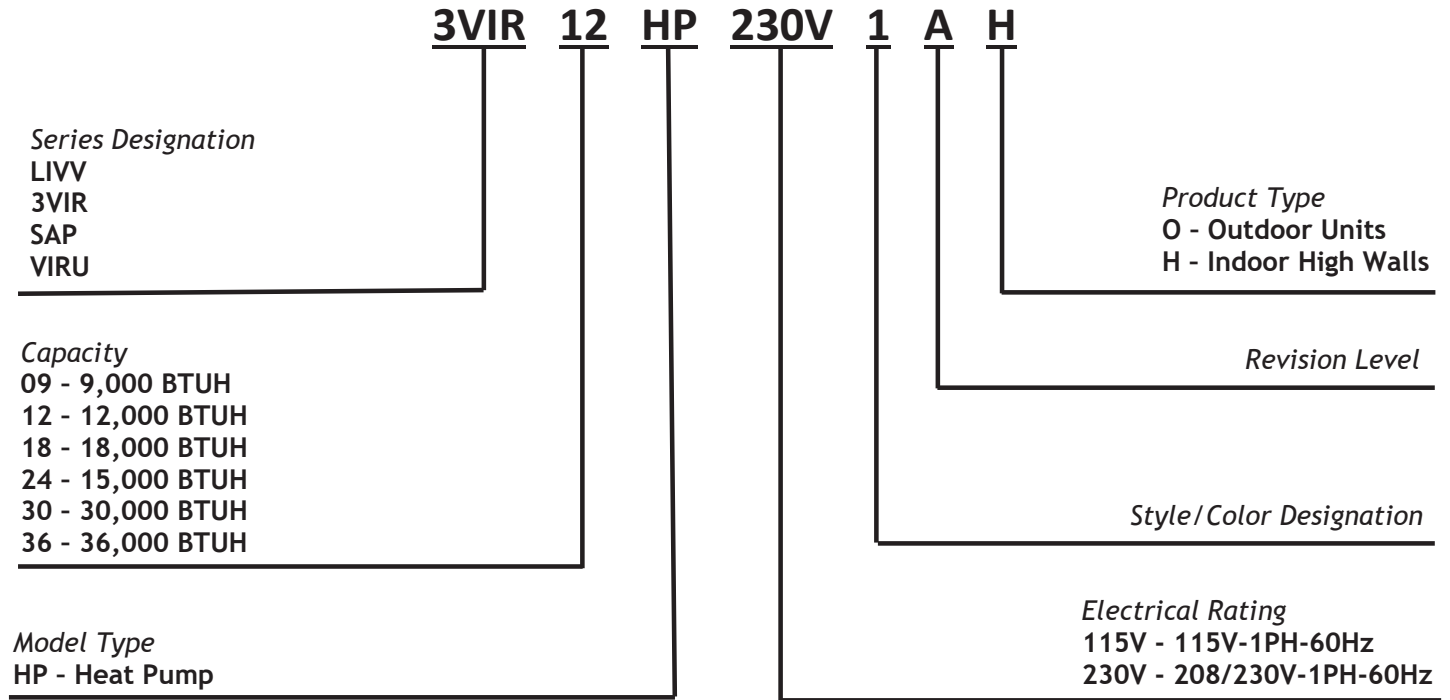

SAFETY PRECAUTIONS

Please read the following before operation

Recognize safety information.  This is the safety-alert symbol. When you see this symbol on the unit and in instructions or manuals, be alert to the potential for personal injury. Understand these signal words: DANGER, WARNING, and CAUTION. These words are used with the safety-alert symbol.

DANGER identifies the most serious hazards which will result in severe personal injury or death.

WARNING signifies hazards which could result in personal injury or death.

CAUTION is used to identify unsafe practices which may result in minor personal injury or product and property damage.

NOTE is used to highlight suggestions which will result in enhanced installation, reliability, or operation.

NOTE: Your actual air conditioning & heating system and related devices may differ from the images shown in this manual.

WARNING

This appliance is not intended for use by children without responsible adult supervision. Proper care should be taken to ensure safety.

WARNING

Heat pumps, air conditioners & heating equipment should be installed, started up, and serviced only by qualified installers and service technicians. Air conditioning, heat pumps and refrigeration systems are hazardous due to high voltage electrical components, high refrigerant pressures, and moving parts.

WARNING

- Disconnect electrical power to the indoor and outdoor units before performing any maintenance or cleaning.
- Do not attempt to repair the GREE system yourself. Incorrect repairs may cause electric shock or fire. Contact a qualified service technician for all service requirements.
- Keep combustible materials away from the unit.

Please read the following before operation

 **CAUTION**

- Do not put hands or any objects into the air inlets or outlets. This may cause personal injury or damage the unit.
- When cleaning, be careful not to splash water on the unit. Doing this may cause electric shock or damage to unit.
- Do not use or place any flammable, combustible or noxious substance next to the unit.
- In the event of a failure (burning smell, etc.), immediately disconnect all electrical power to indoor and outdoor units.
- Never try repairing the system yourself; contact a qualified service technician for all repairs.

PART NAMES

Indoor unit

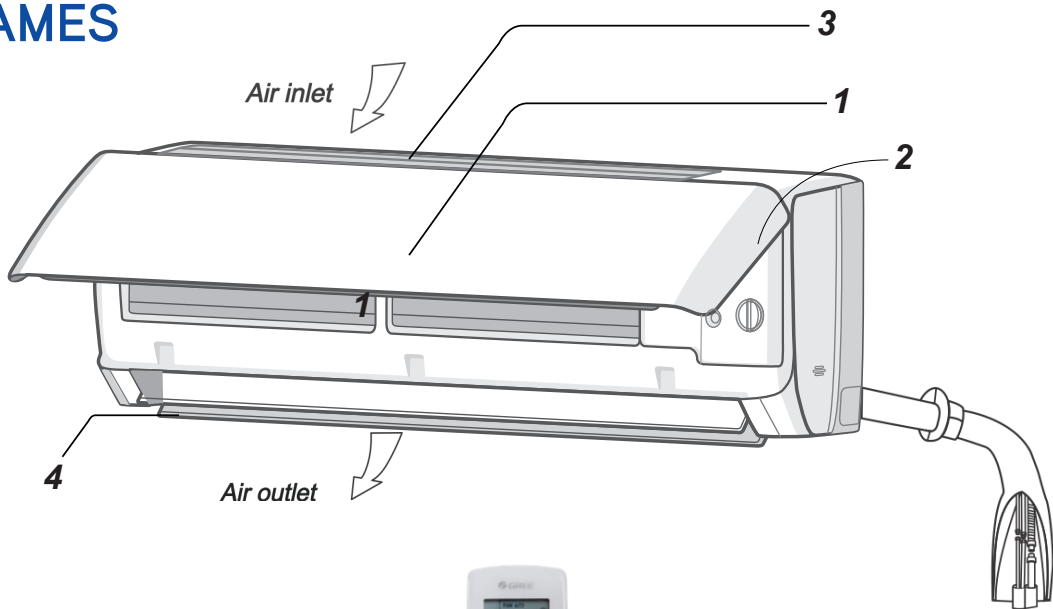

Part Name

1. Front Panel
2. Aux. Button
3. Air Filter
4. Horizontal Louver
5. Remote Controller
6. Wired Controller (sold separately)
7. Inter-connecting Wire (sold separately)
8. Drain Hose (sold separately)
9. Refrigerant Lines (sold separately)

Outdoor unit

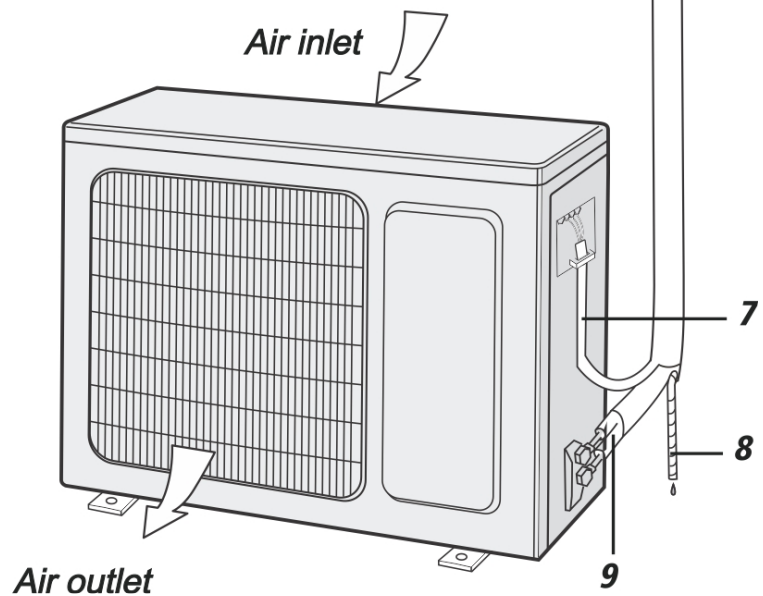

SYSTEM FUNCTIONS

WHISPER QUIET

Not only are the GREE systems energy efficient but they are quiet too. 3VIR High-Wall units operate with sound pressure levels starting as low as 20 dB(A).

MULTI FAN SPEEDS

Whether operating in either Cooling or Heating mode, the indoor fan can be set to your choice of seven fan speed plus Turbo to achieve maximum comfort.

INTELLIGENT PREHEATING

The 3VIR system guards against the annoying cool air blown into the room in heating mode. The system constantly monitors the discharge air temperature. It will delay the indoor fan until the indoor coil has warmed up to prevent blowing uncomfortable cool air into the room.

I-FEEL FUNCTION

The unit will sense room temperature at the remote controller instead of at the indoor unit. It then adjusts airflow and temperature accordingly for ultimate personal comfort.

ADJUSTABLE AIRFLOW

The 3VIR system has a bi-directional airflow control for maximum comfort. The indoor unit has adjustable vertical and horizontal swing louvers and can be set in multiple discharge directions from the wireless remote controller.

TURBO MODE

Use Turbo Mode for situations where you wish to achieve the desired room temperature in the shortest possible time. This mode runs the unit at ultra high speeds for quickest results.

VACATION MODE (FREEZE GUARD)

Vacation mode (freeze guard) set's the unit to 46°F (8°C) in heating to keep the temperature in the space above freezing.

TIMER MODE

The unit can be programmed to turn ON or OFF after a specific amount of time. The time period is adjustable between one half and 24 hours.

MODE BUTTON

The unit can be set to five different operating modes: HEAT COOL, DRY, FAN ONLY and AUTO.

SLEEP MODE

The 3VIR offers a Sleep Mode function for your comfort. The unit will automatically adjust room temperature during your sleep time. This slight change in temperature will not affect your comfort level due to the natural effects that sleeping has on the body but it will save on energy consumption and will lower electric bills.

ENERGY SAVINGS MODE

This feature will automatically select the optimal compressor and fan speeds to allow for energy savings while operating in Cooling or Heating modes. The compressor and fan will automatically slow down as the room temperature reaches the set point.

SELF-DIAGNOSIS

Your 3VIR has a built-in computer which uses real-time diagnostics which help prolong the unit's life. The automatic diagnosis feature continuously scans for errors or malfunctions and fault codes are shown on the unit display to facilitate troubleshooting and repair.

POWER FAILURE MODE

Power interruptions are no problem for the 3VIR system. User selections and system parameters are stored in non-volatile memory. These parameters are retained during a power failure. When power is returned, the 3VIR system will automatically return to the last operating mode.

INTELLIGENT DEFROST

The 3VIR Intelligent Defrost function increases room comfort and saves energy by eliminating unnecessary defrost cycles. In heating mode, the unit will monitor the outdoor coil for frost build up. Once frost buildup has been detected, the system will switch into a defrost mode to remove the frost.

WASHABLE POLYMERIC AIR FILTER

The polymeric mesh filters save energy by preventing the indoor coils from being plugged with dirt and lint. This economical and sturdy filter may be washed, vacuumed and reused.

FAHRENHEIT / CELSIUS

The remote controller and indoor wall unit front panel can be set to display in either °F or °C.

REMOTE LOCK-OUT

The wireless remote controller has a Lock feature. The Lock averts unauthorized access or tampering with system settings.

AGENCY LISTINGS

All systems are listed with AHRI (Air Conditioning, Heating, and Refrigeration Institute) and are ETL certified per UL Standards.

OPERATION OF WIRELESS REMOTE CONTROLLER

Buttons on remote controller

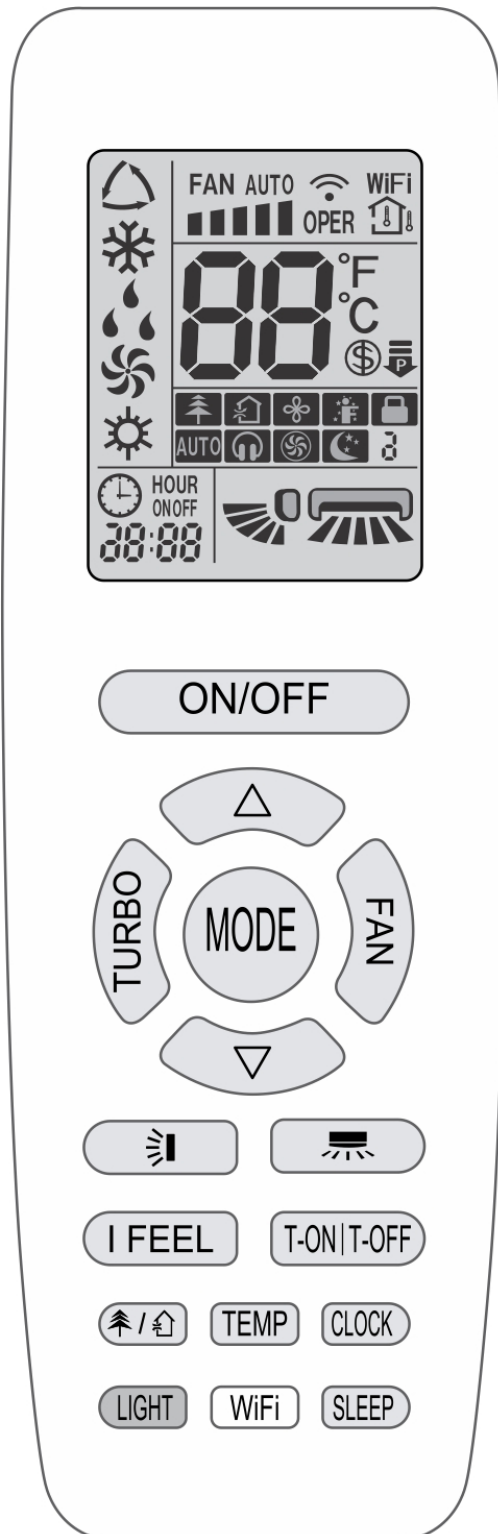



Introduction for icons on display screen

	I-FEEL	
	Set fan speed	
	Turbo mode	
	Send signal	
Operation mode		Auto mode
		Cool mode
		Dry mode
		Fan mode
		Heat mode
		Sleep mode
	46°F Vacation mode	
	Power limiting operation	
	Not available	
	Not available	
	X-FAN function	
		Set temp.
		Indoor ambient temp.
		Not available
	Clock	
	Set temperature	
WiFi	WiFi function	
	Set time	
ONOFF	TIMER ON / TIMER OFF	
	Left & right swing	
	Up & down swing	
	Remote lock-out	
	Quiet	

Introduction for buttons on remote controller

NOTE

- This is a general use remote controller. It could be multiple GREE multi-functional models. If a function is not available on your model, pressing the button will have no effect.
- After turning the power on, the unit will give out a sound. When the power indicator light “”, you can operate the system using the remote controller.
- The signal icon “” will blink once and emit a “di” sound when the ON button is pushed. This indicates a signal has been sent to the unit to turn on.
- To adjust set temperature in AUTO mode, select AUTO mode first then you can adjust the temperature using the remote, the wired controller or the WiFi APP. This remote controller can adjust the “set temperature” in AUTO only because the 3VIR has this capability.









ON/OFF







Press this button to turn on the unit. Press this button again to turn off the unit.

MODE

Press this button to select your required operation mode.









- When selecting the auto mode, the unit will operate automatically according to the factory settings. Press “FAN” button to adjust fan speed. Press “” / “” button to adjust the fan blowing angle.
- After selecting “COOL”, the unit will operate under cool mode. Press the “” or “” button to adjust the set temperature. Press “FAN” button to adjust fan speed. Press “” / “” button to adjust fan blowing angle.
- When selecting dry mode, the air conditioner operates at low speed under dry mode. Under dry mode, fan speed can't be adjusted. Press “” / “” button to adjust fan blowing angle.

- When selecting “FAN”, the unit's will operate in a “fan only” mode (no heating or cooling), and all indicators will be off. All indicators are OFF. Press “FAN” button to adjust fan speed. Press “” / “” button to adjust fan blowing angle.
- When selecting “HEAT”, the air conditioner operates under heat mode. Press “” or “” button to adjust set temperature. Press “FAN” button to adjust fan speed. Press “” / “” button to adjust fan blowing angle.

NOTE

- When selecting the HEAT mode, there will be a 1-5 minute delay to allow the coil to warm up before the fan blows. This prevents cold air blowing at start up.
- Set temperature range from remote controller: 16-30 °C (61-86°F);
- Under AUTO, temperature can be displayed and adjusted.

FAN

This button is used for setting Fan Speed in the sequence that goes from AUTO, , , , , , to , then back to Auto.

NOTE

- Under AUTO speed, the system will select proper fan speed automatically according to factory default setting.
- It's low fan speed under dry mode.
- X-FAN function: Holding fan speed button for 2s in COOL or DRY mode, the icon “” is displayed and the indoor fan will continue operation for a few minutes to dry the indoor coil, even though you have turned off the unit. After start-up, X-FAN OFF is defaulted. X-FAN is not available in AUTO, FAN or HEAT modes.
This function helps remove moisture on evaporator of indoor unit after the unit is stopped.
- Having set X-FAN function on: After turning off the unit by pressing ON/OFF button, indoor fan will continue running for a few minutes at low speed. In this period, hold fan speed button for 2s to stop indoor fan.
Turn off the X-FAN function by pressing the ON/OFF button.

TURBO

Under COOL or HEAT mode, press this button to turn to quick COOL or quick HEAT mode. “☼” icon is displayed on remote controller. Press this button again to exit turbo function and “☼” icon will disappear. This function will allow the unit to run at very high fan speed to reach the desired temperature.

Δ / ▽



- Press “Δ” or “▽” button to increase or decrease the set temperature 1 °C(2°F). Hold “Δ” or “▽” button for 2 Sec, set temperature on remote controller will change quickly. Temperature indicator on indoor unit will change accordingly.
- When setting T-ON, T-OFF or CLOCK, press “Δ” or “▽” button to adjust time. (Refer to CLOCK, T-ON, T-OFF buttons)

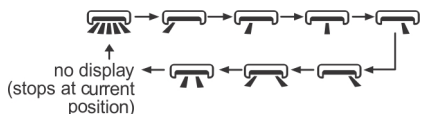

Press this button to select left & right swing angle. Fan blowing angle can be selected circularly as below:







NOTE

- Press this button continuously more than 2s, the louver will swing back and forth from left to right, when you release the button, the louver will stop swinging at its present position.
- Under left and right swing mode, when the status is switched from off to , pressing this button again for 2s and  status will switch to off status; pressing this button again for 2s, will change the swing status according to the sequence shown above.

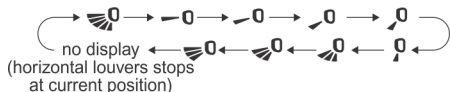



Press this button to select up & down swing angle. Fan angle can be selected circularly as below:



- Select “”, to select automatic fan circulation. Horizontal louver will automatically swing up & down at maximum angle.
- Select “”, and fan modulation will stop at that fixed position. Horizontal louver will stop at the fixed position.
- Select “”, will not modulate but blow at a fixed angle.
- Hold “” button more than 2s to set your required swing angle. When reaching your desired angle, release the button.

NOTE

- Pressing this button continuously for more than 2s, the louver will swing back and forth from up to down, release the button, will stop the louver at the desired position.
- Under up and down swing mode, when the status is switched from off to , Pressing this button again for more than 2s will turn off the  status. Pressing again within 2s, will change the swing status to the diagram above.



T-ON | T-OFF

- T-ON button
“T-ON” button will set the time for timer on. After pressing this button, “⌚” icon disappears and the word “ON” on remote controller blinks. Press “Δ” or “▽” button to adjust T-ON setting. After each pressing “Δ” or “▽” button, T-ON setting will increase or decrease 1min. Hold “Δ” or “▽” button, 2s longer and the time will change quickly until reaching your desired time. Press “T-ON” to confirm. The word “ON” will stop blinking. “⌚” icon resumes displaying. Cancel T-ON: If T-ON is initiated, press “T-ON” button to cancel it.
- T-OFF button
“T-OFF” button will set the time for timer off. After pressing this button, “⌚” icon disappears and the word “OFF” on remote controller blinks. Press “Δ” or “▽” button to adjust T-OFF setting. After each press of the “Δ” or “▽” button, T-OFF setting will increase or decrease 1 min. Holding the “Δ” or “▽” button for more than 2s the time will change quickly until reaching your desired time. Press “T-OFF” and “OFF” will stop blinking. “⌚” icon resumes displaying. To cancel T-OFF when it’s on, “T-OFF” button to cancel it.

NOTE









- Under status, you can set T-OFF or T-ON simultaneously.
- Before setting T-ON or T-OFF, please set the clock.
- After starting T-ON or T-OFF, set to “circulating” mode.
- Your unit will be turned on or turned off according to setting. ON/OFF button has no effect on setting. If you don't need this function, please use remote controller to cancel it.

I FEEL

Press this button to start I FEEL function and “” will be displayed on the remote controller. When set, the remote controller will send the detected ambient temperature to the controller and the unit will automatically adjust the indoor temperature according to the detected temperature. Press this button again to cancel I FEEL function and “” will disappear.

- Put the remote controller near the user when this function is set. Avoid putting the remote controller near an object of high or low temperature. When I FEEL function is turned on, the remote controller should be put where the indoor unit can receive the signal sent by the remote controller.



CLOCK

Press this button to set clock time. “” icon on remote controller will blink. Press “” or “” button within 5s to set clock time. Pressing the “” or “” button, clock time will increase or decrease 1 min. If you hold “” or “” button for longer than 2s the time will change rapidly. Release this button when reaching your required time. Press “CLOCK” button to confirm the time. “” icon stops blinking.

NOTE



- This is a 24 hour clock.
- A delay of more than 5s in setting the ON and OFF times will cancel the set-up and you will have to start over. Operation for TIMER ON/TIMER OFF is the same.



SLEEP

- Press this button, can select Sleep 1 ( 1), Sleep 2 ( 2), Sleep 3 ( 3) and cancel. If the unit is turned OFF, the SLEEP mode will have to be re-set.
- Sleep mode 1; in COOL mode: after running one hour, the temperature will increase 2°F, in two hours it will increase by 4°F and will maintain that setting

until cancelled. In HEAT mode: after running 1 hour, the temperature will decrease 2°F, in 2 hours the temperature will decrease another 4°F and maintain that setting until cancelled.

- SLEEP mode 2; The unit will run according to a preset temperature curve.
- SLEEP MODE 3 will require you to enter eight (8) room setpoint values for eight (8) hours of run time. The last room setpoint value will be maintained until sleep mode is cancelled.

In Sleep Mode 3, press “Turbo” button to enter setup mode. The remote controller will display “1 hour” in the time location. Use the “” or “” buttons to select the desired room setpoint for the first hour of run time. Then press the “Turbo” button to save the setpoint.

The remote controller time display will change to “2 hours.” Once again, use the “” or “” buttons to select the desired room setpoint for the second hour of run time, and press the “Turbo” button to again save the setpoint.

Repeat this sequence for the eight (8) room setpoint values. After all eight (8) values have been entered, the remote controller will automatically revert to standard time and temperature display, and the Sleep 3 Mode will begin.

At any time, you may press the “ON/OFF,” “Mode” or “Sleep” buttons to cancel the Sleep 3 Mode.

NOTE

- During this procedure, if no button is pressed within 10 seconds, remote controller will automatically exit the sleep curve setting and resume original display. If ON/OFF, SLEEP, COOLING or HEATING button is pressed during the setting or inquiry procedure, remote controller will also exit the sleep curve setting.

WiFi

Press the “WiFi” button to turn on the WiFi function, the “WiFi” icon will be displayed on the remote controller; Hold the “WiFi” button for 5s to turn off the “WiFi” function and the “WiFi” icon will disappear.

When the unit is OFF, press “MODE” and “WiFi” buttons simultaneously for 1s and the WiFi module will return to the factory settings.

NOTE

- This function is available for the Vireo GEN3 models but may not be available for other models.

LIGHT

Press this button to turn off display light on indoor unit. “” icon on remote controller disappears.

Press this button again to turn on display light. “” icon is displayed.

TEMP

Press this button to see the indoor set temperature on the unit's display. The setting on remote controller is selected circularly as below:



Function introduction for combination buttons

Energy-saving function

Under COOL mode, press “TEMP” and “CLOCK” buttons simultaneously to start up or turn off energy-saving function. When energy-saving function is started up, “SE” will be shown on remote controller, and the unit will adjust the set temperature automatically, to the factory setting, to achieve maximum energy savings. Press “TEMP” and “CLOCK” buttons simultaneously again to exit energy-saving function.

NOTE

- Under energy-saving function, fan speed defaults to Auto and can't be adjusted.
- Under energy-saving function, you cannot adjust Fan speed or use TURBO.
- If the energy-saving function has been set in the COOL mode, pressing the “SLEEP” button will cancel energy-saving. If the SLEEP function has been set in the COOL mode, starting the energy-saving function will cancel SLEEP.

Vacation mode (freeze guard) Heating in 8°C mode or 46°F mode





In the HEAT mode, press “TEMP” and “CLOCK” buttons simultaneously to start up or turn off this heating function. When this function is started up, “” and

“46°F (8°C)” will be shown on remote controller, and the space will not fall below 46°F (8°C). Press “TEMP” and “CLOCK” buttons simultaneously again to exit “46°F (8°C)” heating function.

NOTE

- Under 46°F (8°C) heating function, fan speed is defaulted at auto speed and it can't be adjusted.
- Under 46°F (8°C) heating function neither the temperature nor the fan speed can be adjusted. “TURBO” will not work either.
- Sleep function and 46°F (8°C) heating function can't operate at the same time. If 46°F (8°C) heating function has been set under heat mode, pressing the “SLEEP” button will cancel 46°F (8°C) heating function. If sleep function has been set under heat mode, initiating the 46°F (8°C) heating function will cancel SLEEP function.

Remote lock-out

Press “” or “” simultaneously to turn on or turn off Remote lock-out. When Remote lock-out is on, “” icon is displayed on remote controller. If you operate the remote controller, the “” icon will blink three times without sending signal to the unit.

Temperature display switchover function

Under OFF status, press “” and “MODE” buttons simultaneously to switch temperature display between °C and °F.

Auto clean function

With the unit OFF, hold “MODE” and “FAN” buttons simultaneously for 5s to turn the Auto Clean function on or off. When the Auto Clean function is turned on the indoor unit displays “CL” and the unit will cool down and heat up rapidly. The noise you may hear is the sound of liquid refrigerant or possibly thermal expansion and contraction, this is normal. During the process cool or warm air may blow, this is also normal. While in the Auto Clean mode please make sure the room is well ventilated to avoid any discomfort.

NOTE

- The Auto Clean function will not work under excessively hot or cold outdoor temperatures. If the room is dusty, clean it once a month; if not, clean it once every three months. After the Auto Clean function is turned on, you can leave the room. When Auto Clean is finished, the unit will enter standby status.
- This function is only available for some models including the Vireo GEN3 series.

NOTICE

- During operation, point the remote control signal sender at the receiving window on indoor unit.
- The distance between signal sender and receiving window should be no more than and there should be no obstacles between them.
- Other electronics may interfere with the remote signal remote controller should be close to indoor unit during operation.
- Replace batteries with an equivalent model when replacement is required.
- When you don't use remote controller for a long time, take out the batteries.
- If the display on remote controller is fuzzy or there's no display, replace batteries.

Replacing batteries in remote controller

Fig 1

Fig 2

1. Lift the cover along the direction of arrow (as shown in Fig 1 ①).
2. Take out the original batteries (as shown in Fig 1 ②).
3. Place two (AAA 1.5V) dry batteries, and make sure the position of “+” polar and “-” polar is correct (as shown in Fig 2 ③).
4. Reinstall the cover (as shown in Fig 2 ④).

DAMAGED OR LOST REMOTE CONTROLLER

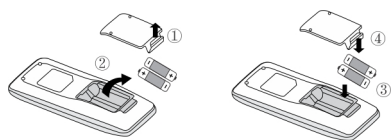
If remote controller is lost or damaged, please use aux. button to turn on or turn off the air conditioner. The operation in details is as below: As shown in the figure, open panel and press aux.button to turn off the air conditioner. When the air conditioner is turned on, it will operate under auto mode.

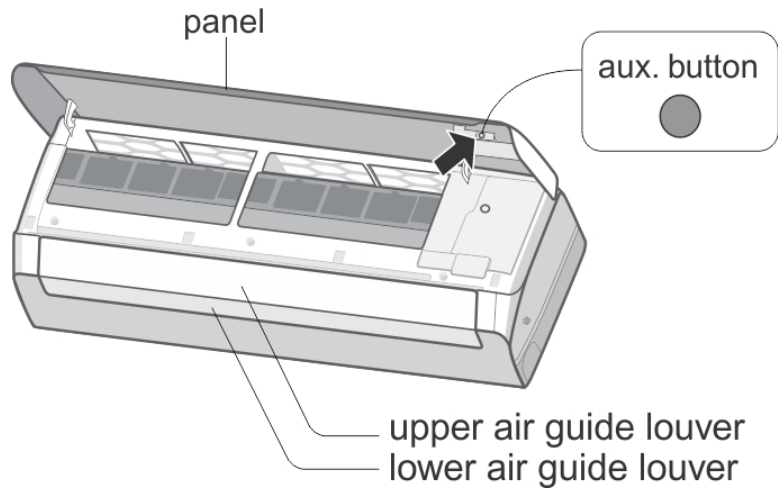

WIFI SETUP

To set up a Wi-Fi connection with the Vireo Gen3 high wall, please follow these steps:

1. Download and install the Gree+ app from the Apple App Store or the Google Play Store.

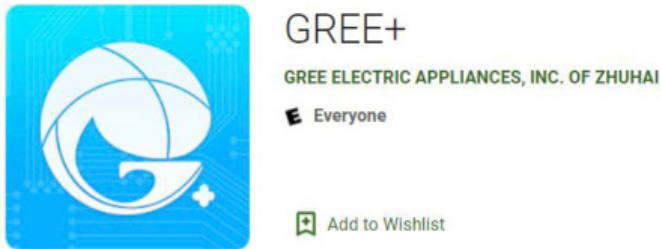

2. Launch the Gree+ app by clicking on the Gree+ app icon on your phone.
3. Log into the Gree+ app using your login ID and password. First-time users will need to click the “Sign Up” button and follow the on-screen instructions to create an account.
4. Activate Wi-Fi pairing mode by using the remote control. Press and hold the Wi-Fi button until the Wi-Fi icon appears on the screen of the remote control. This should be accompanied by an audible beep. The unit will remain in Wi-Fi pairing mode for 2 minutes. If pairing is not completed within two minutes, use the remote to turn the unit off, then press and hold the Mode and Wi-Fi buttons at the same time until an audible beep is heard. This will reset the Wi-Fi module.
5. Once Wi-Fi pairing mode is active, click on the “+” sign located at the top right-hand corner of the Gree+ app home screen.

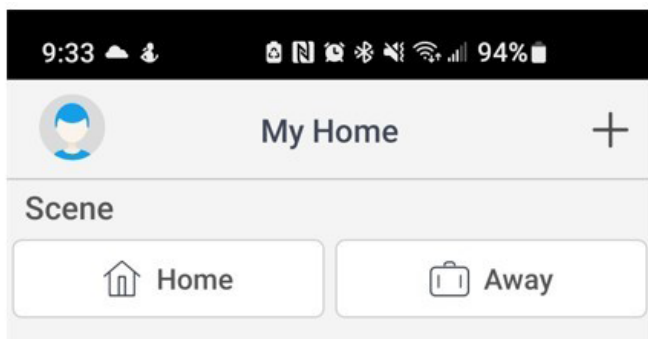

6. The app will automatically search for the active Wi-Fi signal from the high wall unit. If the app does not automatically detect the unit, select the AC icon from the list of product boxes and follow the on-screen prompts to manually add the unit.

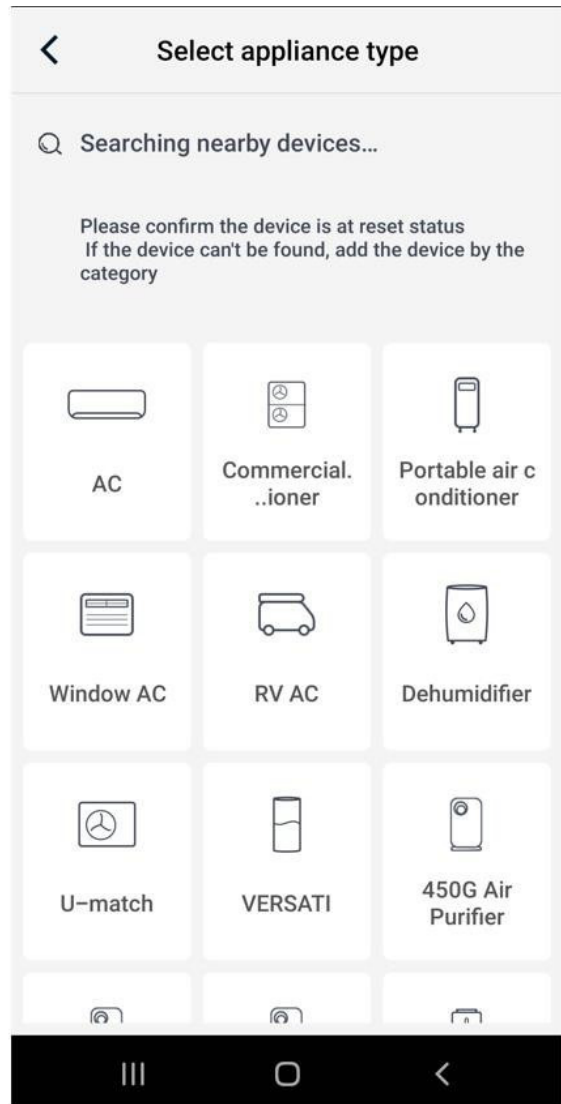

7. Follow the on-screen prompts to connect the unit. After pairing the unit with the app, you will be prompted for the Wi-Fi network to be used with the unit. Select the proper Wi-Fi network ID and enter the network password. Please note the unit is not compatible with 5 GHz networks.

CARE AND CLEANING

⚠ WARNING

- Turn off the air conditioner and disconnect the power before cleaning the air conditioner to avoid electric shock.
- Do not wash the air conditioner with water to avoid electric shock.
- Do not use volatile liquid to clean the air conditioner.
- Do not use liquid or corrosive detergent to clean the appliance and do not splash water or other liquid on it to avoid damaging the plastic components or causing an electric shock.

Clean surface of indoor unit

When the surface of indoor unit is dirty, it is recommended to use a soft dry cloth or wet cloth to wipe it.

NOTICE

- Do not remove the panel when cleaning it.

Clean filter

1. REMOVE FILTER

Press the spring fasteners at both sides in the direction indicated by the arrows.

Meanwhile, lift up the filter so that it is separated from the fasteners.

Pull the filter forward and remove it.

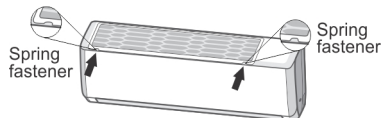

2. CLEAN FILTER

Use clean water to wash or a duster to clean it. If the filter is very dirty (such as grease), clean with warm water, do not dry in excessive heat.



3. INSTALL FILTER

After cleaning, reinstall the filter in reverse order. Push it along the guide rails at both sides and then press the left and right edges of the filter. Refit the filter in the direction indicated by the arrows.



⚠ WARNING

- The filter should be cleaned every one – three months. If there is lot of dust in the operation environment, filter needs to be cleaned frequently.
- After removing the filter, do not touch fins to avoid injury.
- To avoid deformation or a fire hazard, do not use excessive heat when drying the filter.

NOTICE: Seasonal start-up tips

1. Make sure air inlets and air outlets are clear.
2. Check to see the circuit breaker and wiring are in good condition.
3. Check if the filter is clean.
4. Check mounting bracket for outdoor unit for damage and corrosion. If yes, please contact dealer.
5. Check to see the drain pipe is not damaged.

NOTICE: Seasonal shut-down tips

1. Disconnect power supply.
2. Clean filter and indoor unit's panel.
3. Check the outdoor mounting bracket, have local contractor replace if damaged or corroded.

Recycle Please

1. Many packing materials are recyclable materials. Please dispose them in appropriate recycling bin.
2. If you want to dispose this unit, contact a local contractor or authority for assistance.

Error Code

When the system not working properly, the temperature indicator on indoor unit will blink to display corresponding error code. Please refer to below list for identification of error code.

Error code	Troubleshooting
U8, H6, H3, E1, E5, E6, E8	Try restarting the unit. If this does not correct the problem contact a qualified HVAC technician.
C5, F0, F1, F2	Please contact qualified professionals for service.
E7	Mode Conflict, please make sure all the indoor units are running either on "COOL" or "HEAT" mode in a multi-zone application.
E2, E9	These are not error code, they are operational Status Code.

NOTE

- If there're other error codes, please contact qualified professionals for service.

TROUBLESHOOTING

General problem analysis

Please check below items before asking for maintenance. If the problem still can't be eliminated, please contact local dealer or qualified professionals.

Problem	Check items	Solution
Indoor unit isn't receiving the remote controller signal.	Interference from static electricity	Disconnect power at breaker for 3 minutes.
	Is the remote controller within the signal receiving range?	Signal receiving range is 26 ft.
	Are there any obstacles?	The remote needs to have a clear path to the indoor unit receiver.
	Is the remote controller pointing at the receiving window?	Select proper angle and point the remote controller at the receiving window on indoor unit.
	Is sensitivity of remote controller low; fuzzy display or no display?	Check the batteries. If the power of batteries is too low, please replace them.
	No display when operating remote controller?	Check whether remote controller appears to be damaged. If yes, replace it.
	Electronic Interference?	Take the remote controller close to indoor unit. Turn off other electronics and then try it again.
No air coming from indoor unit	Air inlet or air outlet of indoor unit is blocked?	Eliminate obstacles.
	In the HEAT mode, has the indoor temperature reached the set temperature?	After reaching set temperature, the indoor fan will stop.
	You just turned on the HEAT mode.	In order to prevent cold air from blowing out it may take several minutes before the fan starts. This is normal.
Air conditioner isn't coming on	Power failure?	Wait until power recovery.
	Loose wiring?	Contact your contractor or an electrician.
	Circuit breaker has tripped or fuse is burnt out?	Ask professional to replace circuit breaker or fuse.
	Wiring is overheating or needs repair.	Ask professional to replace it.
	Unit has restarted immediately after stopping operation?	Turn the unit off, wait 3 minutes then turn it back on.
	Does the remote controller show the correct setting?	Reset the function.
Mist coming from indoor unit's air outlet	Indoor temperature and humidity is high?	Happens when the indoor air is cooled rapidly. After a while, indoor temperature and humidity will be decrease and mist will disappear.

Problem	Check items	Solution
Strange smells?	Look for the source of the odor; rugs, furniture, cigarettes, etc.	Eliminate the odor source. Clean the filter.
Can't adjust the "Set" temperature	Your required temperature exceeds the set temperature range?	Set temperature range: 16°C-30°C (61°F-86°F).
Cooling / Heating is insufficient.	Voltage is too low?	May require calling an HVAC technician.
	Filter is dirty?	Clean the filter.
	Set temperature is in proper range?	Adjust temperature to proper range.
	Door and window are open?	Close door and window.
Air conditioner operates abnormally	Is there interference, such as lightning, wireless devices, etc.	Disconnect power, put back power, and then turn on the unit again.
"Water flowing" noise	The unit has just been turned on or off.	The noise is the sound of refrigerant flowing inside the unit, which is a normal.
Cracking noise	The unit has just been turned on or off.	This is the sound of friction caused by expansion and/or contraction of panel or other parts due to temperature changes.
Air guide louver can't be closed normally	Did you try to adjust the air guide louver manually? Did it stick during normal operation?	Disconnect the power for 3s and then connect the power; if the problem still exists, call an HVAC technician to resolve.



WARNING

- When the following occurs, turn the unit off and disconnect power immediately, contact your installing contractor or a licensed HVAC technician.
 - Power supply wiring is overheating or damaged.
 - There's abnormal sound during operation.
 - Circuit breaker trips off frequently.
 - Air conditioner gives off burning smell.
 - Indoor unit is leaking.
- Do not try to service or repair the unit yourself.
- If the unit operates abnormally it may cause internal or external damage, electric shock or become a fire hazard.

ENERGY SAVING TIPS

1. Reduce room setpoint at night: During the night hours, you don't require the same level of conscious cooling or heating. Try using Sleep Mode to gradually relax room temperature and allow the unit to run less and save energy.
2. Curtains and shades: In the summer, it is recommended to block the effects of the sun. Close window curtains and shades on the south and west side of your home to help block solar heat. In winter, the sun is your friend. Open curtains and shades to allow solar heat into your room.
3. Close doors: If you don't need to heat and cool your whole home, confine the heating and cooling to one room by closing doors.
4. Service the unit: Some basic maintenance might be all you need. The outdoor unit will greatly benefit from a good hosing off, leaves, grass clippings and other debris can stick to coil fins and make the unit work up to 15% harder!
5. Rearrange the room: Furniture that obstructs the airflow, needs to be removed or rearranged accordingly.
6. Try 75 degrees: 75°F is a good point for an air conditioner to run at its optimal performance level. Even a 5-degree change in temperature can make your unit use up to 40% more energy.
7. Lighting: Turning lights off can help reduce your heat. Each light bulb is a tiny heater. Your air conditioner must waste energy overcoming the heat from your lights to reach and hold your desired room temperature.
8. Zero occupancy: During zero occupancy turn your unit to Auto mode and make sure windows and curtains are closed. Although room temperature may be less than optimal for a few minutes when you return, the unit will soon have the room back to your desired temperature.
9. Don't forget the fan: The fan is much like a car. The faster it runs, the more energy it uses. Try saving money by using the comfortable quiet low fan speed as much as possible.

REGISTRATION

FOR WARRANTY SERVICE OR REPAIR:

Contact your installing contractor. You may find the installer's name on the equipment or in your Owner's packet or on your invoice.

ONLINE REGISTRATION IS AVAILABLE AT:

<https://www.greecomfort.com/warranty-program/#registration>



COMPLETE THE PRODUCT REGISTRATION BELOW:

Keep this for your files.

PRODUCT REGISTRATION:

Indoor Model No: _____ Serial No: _____

Outdoor Model No: _____ Serial No: _____

Owner Name: _____ Date of Installation: _____

Address of Installation: Installing Contractor: _____

Address: _____

Phone No. / E-mail: _____

WARRANTY

For current warranty information please visit <https://gree-comfort-dev.web.app/warranty-program/>





Air comfort for all

U.S. CONTACT INFORMATION TRADEWINDS, LLC

E-mail: info@twciimate.com

Contractor Support: 888-850-7928 | Mon-Fri 8 AM - 5 PM EST

GREECOMFORT.COM